

**IT**

Struttura in acciaio inox AISI 304; finitura esterna satinata scotch-brite; spessore di isolamento pari a 60mm, con schiumatura ad alta densità (40 kg/mc) senza HFC; piedini in acciaio inox regolabili; cella con angoli interni arrotondati per una perfetta pulizia ed igienicità; griglie in filo facilmente rimovibili per il contenimento di bacinelle GN 1/1 o 60x40; circolazione frontale dell'aria all'interno del vano tecnico, per una distribuzione uniforme dei flussi; porte reversibili auto-chiudenti a molla, dotate di guarnizione magnetica asportabile; micro-porta per fermare la ventola a porta aperta; sonda al cuore di serie disponibile anche nella versione riscaldata; alimentazione a 400V/50Hz trifase.

**EN**

Stainless steel AISI 304 monocoque structure; scotch-brite external satin finish; 60 mm high density HFC free polyurethane foam insulation (40kg/m3); stainless steel adjustable feet; cell with rounded internal edges for a perfect cleaning and hygiene; easily removable wire grids for GN 1/1 or 60x40 containers; frontal air circulation inside the technical compartment for a uniform distribution of the flows; reversible spring return door with removable magnetic gasket; door switch to stop the fan when the door is open; core probe available also in the heated version; standard power supply 400V/50Hz three-phase.

**FR**

Structure à caisse unique en acier inox AISI 304; finition extérieure satinée Scotch-brite; épaisseur d'isolation par injection de mousse polyuréthane à haute densité (40 kg/m3) sans HFC de 60 mm; pieds réglables en acier inox; chambre froide avec angles internes arrondis pour un nettoyage et une hygiène parfaits; grilles métalliques facilement amovibles pour le stockage des bacs GN 1/1 ou 60x40; circulation frontale de l'air à l'intérieur du compartiment technique pour une répartition uniforme des flux; porte réversible avec retour à ressort avec joint magnétique amovible; micro-porte pour arrêter le ventilateur lorsque la porte est ouverte; sonde à piquer de série même dans la version chauffé; alimentation standard 400V/50Hz trois phase.

**DE**

Monocoque-Ausführung aus Edelstahl AISI 304 mit satinierten Außenflächen (Scotch-Brite); 60 mm starke Isolierung aus hochverdichtetem Polyethanschaum (40kg/m3) ohne HFC; Stellfüße aus Edelstahl; Kühlzelle mit abgerundeten Innenecken für eine einfache Reinigung und optimale Hygiene; leicht herausnehmbare Roste für Behältern GN 1/1 oder 60x40; frontales Umlauf der Luft im Maschinenfach für eine gleichmäßige Verteilung des Luftstroms; Federbelastete umkehrbare Tür mit abnehmbarer Magnetdichtung; Türschalter zum ausschalten des Gebläse bei offener Tür; Kerntemperaturfühler als Standardausstattung, auch beheizt lieferbar; Standard Spannung 400V/50Hz dreiphasig.

**ES**

Estructura monocasco de acero inoxidable AISI 304; acabado exterior satinado scotch-brite; espesor de aislamiento 60 mm con espuma de poliuretano de alta densidad (40 kg/m3) sin HFC; piés ajustable de acero inoxidable; cámara con equinas interiores redondeadas para un perfecta limpieza; fácil acceso al evaporador para facilitar la limpieza; rejillas de alambre fácilmente desmontable para la contención de cubetas GN 1/1 o 60x40; circulación frontal del aire dentro del compartimento técnico para una distribución uniforme de los flujos; puerta reversible con retorno por resorte y equipada con junta magnética extraíble; micro puerta para detener el ventilador cuando la puerta está abierta; sonda de núcleo estándar también disponible en la versión calentada; alimentación 400V/50Hz trifásica.



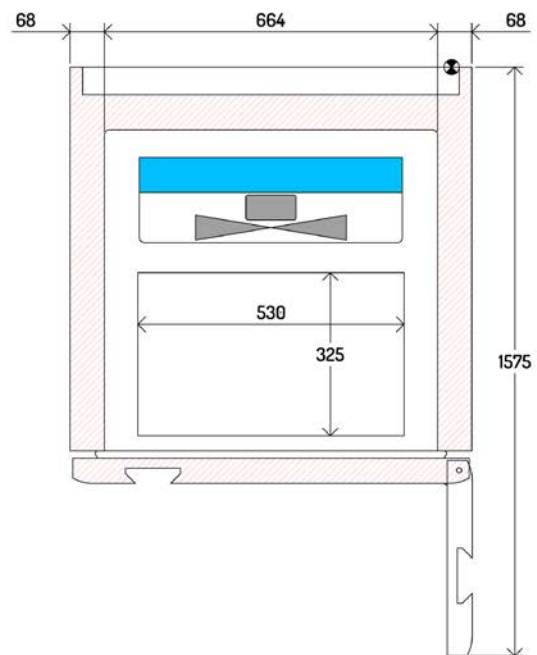
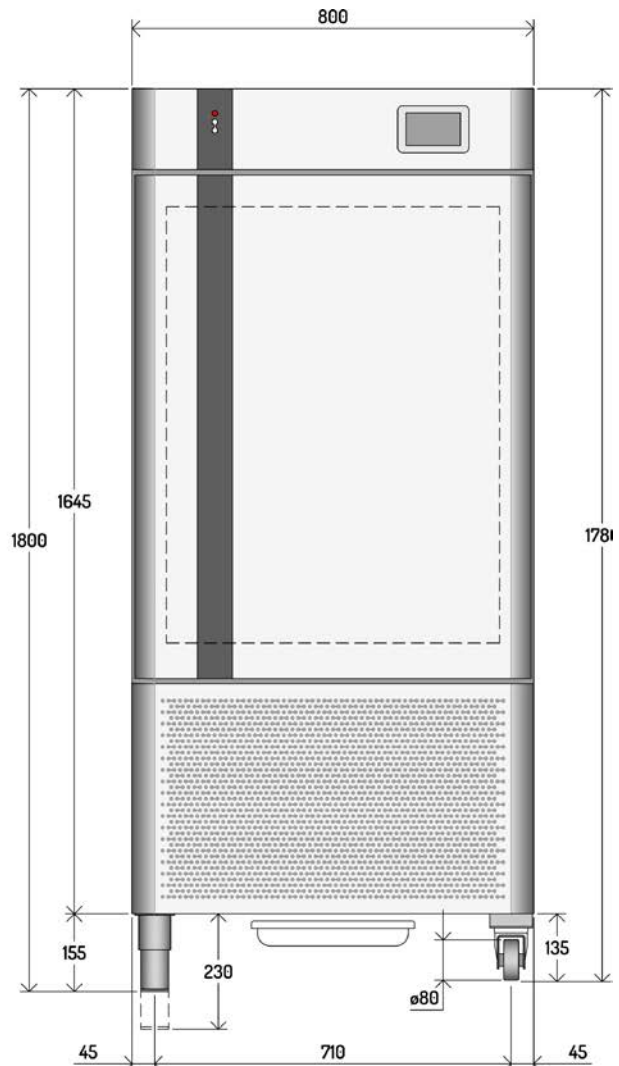
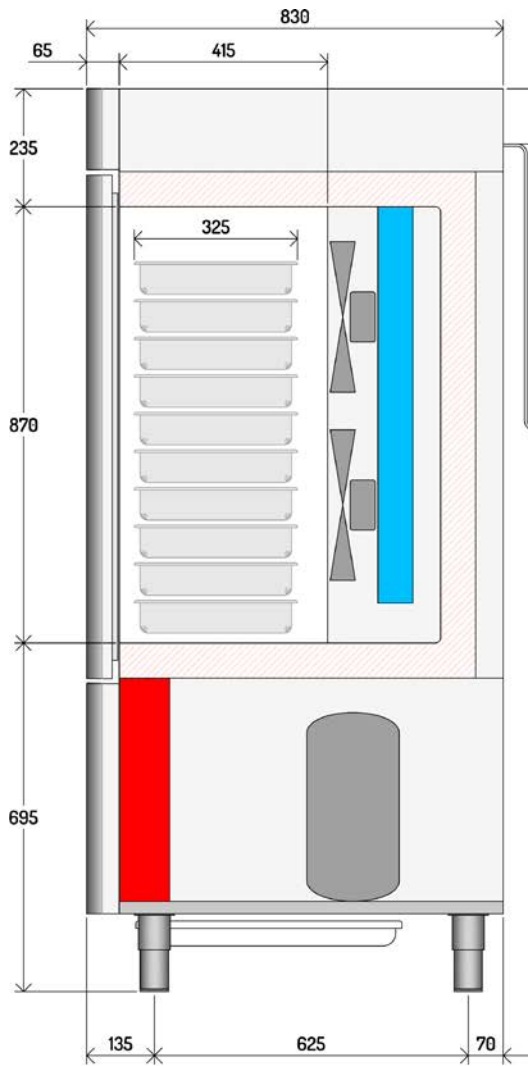

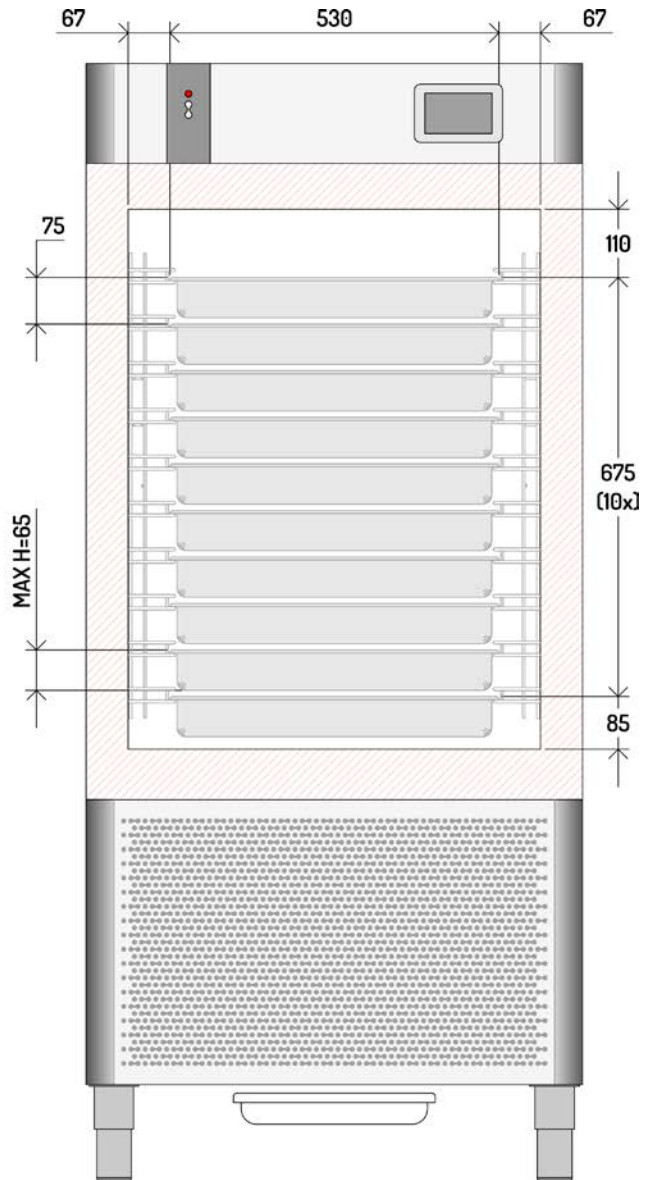
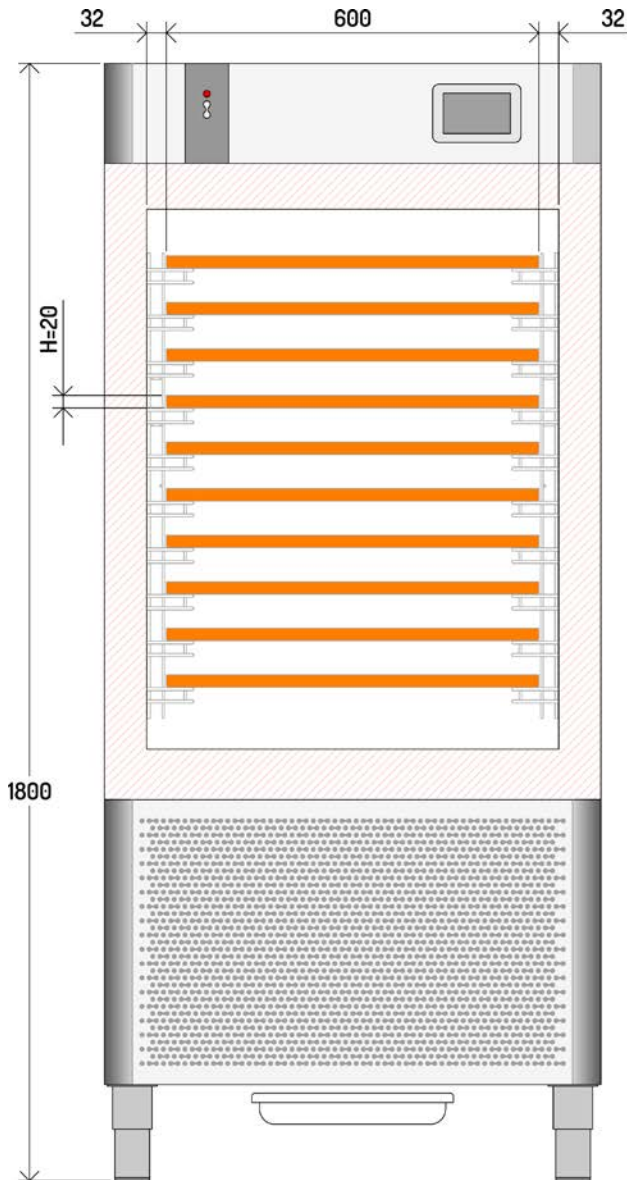

Il costruttore si riserva il diritto di apportare modifiche ai prodotti senza preavviso.  
 The manufacturer reserves the rights to modify its products without prior notice.  
 Le constructeur se réserve le droit d'apporter des modifications aux produits sans préavis.  
 Veränderungen an den Produkten können vom Hersteller ohne Vorankündigung vorgenommen

ILSA  
 S.p.A

Via Ferrovia, 31  
 I - 31010 Castello Roganzuolo  
 di San Fior (Tv)  
 ITALY

Tel. +39 0438 4905  
 Fax +39 0438 400791



<b>Modello</b> - Model - Model - Gerätetyp - Modelo	<b>AB10E4010</b>
---	------------------

GN





	<b>Descrizione</b> - Description - Description - Beschreibung - Descripción		<b>10T 1/1</b>
	<b>Tipo di teglie</b> - Trays type - Type de plateaux - Blechetyp - Tipo de fuentes		GN 1/1 - 600x400
	<b>Capacità Massima</b> - Teglie H=65 - Max load capacity - Trays H=65 - Capacité maximale - Plateaux H=65 Fassungvermögen - Bleche H=65 - Número máximo de fuentes H=65	N°	10
	<b>Interasse griglie</b> - Grids pitch - Pas des grilles - Gitterabstax - Intereje fuentes	mm	75
	<b>Ciclo Positivo</b> - Positive cycle - Cycle positif - Positiver Zyklus (+90° ... +3°)	kg	40
	<b>Ciclo Negativo</b> - Negative cycle - Cycle negatif - Negativer Zyklus (+90° ...-18°)	kg	25
	<b>Dimensioni esterne</b> - External Dimension - Dimensions externes - ußenabmessungen - Dimensiones externas		
	Lunghezza - Width -Largeur - Breite - Anchura	mm	800
	Profondità / con porte aperte - Depth / with open doors Profondeur avec portes ouverte Tiefe/mit geöffneter Tü - Profundidad / con puerta abierta	mm	825/1585
	Altezza - Height - Hauteur - Höhe - Altura	mm	1800
	<b>Dimensioni interne</b> - Internal Dimension - Dimensions internes - Innenabmessungen - Dimensiones internas		
	Lunghezza - Width -Largeur - Breite - Anchura	mm	664
	Profondità - Depth - Profondeur - Tiefe - Profundidad	mm	415
	Altezza - Height - Hauteur - Höhe	mm	870
	<b>Sbrinamento</b> - Defrost - Dégivrages - Abtauen - Descongelación		Automatico a gas caldo Automatic by hot gas Automatique par gaz chaud Automatische durch heissem Gas Automático con gas caliente
	Evaporazione acqua sbrinamento - Evaporation of defrost water - Evaporation eau de dégivrage Tauwasserverdunstung - Evaporación agua de condensación		Manuale - Manual Manuelle - Handentleerung - Manual
	<b>Compressor</b>		
	Model		H180CS
	Potenza - Power - Puissance - Leistung	HP	1,8
	T° Evaporation	°C	-25
	Potenza frigorifera - Refrigerant Power - Puissance frigorifique - Kälteleistung	watt	2080
	<b>Refrigerante</b> - Refrigerant type - Réfrigérant type - Kältemitteltyp - Refriante	GWP	R452A (GWP 2140)
	<b>Quantità di refrigerante</b> - Refrigerant quantity - Quantité de réfrigérant - Kältemittelmenge	gr	1800
	<b>Classe Climatica</b> - Climate Class - Classe Climatique - Klima Classe		+16°C ... +32°C
	<b>Potenza assorbita</b> - Total Power - Puissance - Leistung - Potencia	W - A	2500
	<b>Tensione alimentazione</b> - Supply Voltage - Tension d'alimentation - Anschlussspannung - Alimentación	V	400V 3N~ 50Hz
	<b>Peso Netto</b> - Net weight - Poids net - Netto Gewicht - peso neto	kg	190 (210)

 <b>Modello</b> - Model - Model - Gerätetyp - Modelo	<b>10T 1/1</b>
--	----------------

GN



 <b>Tensione alimentazione</b> - Supply Voltage - Tension d'alimentation - Anschlussspannung - Alimentación	<b>380V 3N~ 60Hz</b> Version	<b>AB10E3010</b>
	<b>220V 3~ 60Hz</b> Version	<b>AB10E1010</b>
	<b>Condensazione ad acqua</b> - Water condensation - Condensation à eau Kondensation durch Wasser - Condensación por agua	<b>400V 3N~ 50Hz</b>
 <b>Versione Predisposta</b> - Remote version - Version sans groupe - Modele ohne Aggregat	<b>220-240V~ 50/60Hz</b>	<b>AB10E4210</b>
	Potenza assorbita - Total Power - Puissance - Leistung - Potencia	
Sbrinamento - Defrost - Dégivrages - Abtauen - Descongelación		Manual air defrosting
<b>Codice Unità Refrigerante</b> - Refrigerant Unit Code - Unitè Refrigerante - Kühleinheit	<b>400V 3N~ 50Hz</b>	ACAB0021 - 1,8 HP
		ACAB0031 - 2,2 HP

↘	<b>Modello unità</b> - Unit model - Modèle unité - Kühleinheit Gerätetyp - Modelo unidad	<b>ACAB0021</b> 1,8 HP	<b>ACAB0031</b> 2,2 HP
---	--	---------------------------	---------------------------



	<b>Ciclo Positivo</b> - Positive cycle - Cycle positif - Positiver Zyklus (+90° ... +3°)	kg	<b>40</b>	<b>40</b>
	<b>Ciclo Negativo</b> - Negative cycle - Cycle negatif - Negativer Zyklus (+90° ...-18°)	kg	<b>25</b>	<b>25</b>

	<b>Dimensioni esterne</b> - External Dimension - Dimensions externes ußenabmessungen - Dimen. estemas			
	Lunghezza - Width -Largeur - Breite - Anchura	mm	755	930
	Profondità - Depth - Profondeur - Tiefe - Profundidad	mm	800	680
	Altezza - Height - Hauteur - Höhe - Altura	mm	460	460

	<b>Compressor</b>			
	T° Evaporation	°C	-25	-25
	Model		H180CS	H221CS
	<b>Potenza compressore</b> - Total Power - Puissance - Leistung - Potencia	HP	<b>1,8</b>	<b>2,2</b>
	<b>Potenza frigorifera</b> - Refrigerant Power - Puissance frigorifique Kälteleistung - Rendimiento frigorífico	watt	2080	2620

	<b>Refrigerant</b>			
	Type		R452A (GWP2140)	R452A (GWP2140)
			R404A (GWP3922)	R404A (GWP3922)
	Quantity (for 10 mt)	kg	2,5	4
	Quantity (for 20 mt)	kg	3,2	5
	Quantity (for 30 mt)	kg	3,9	6,1

	<b>Bore Pipes</b>			
	Suction Line	mm	ø16	ø18
	Liquid Line	mm	ø12	ø12
	Hot Gas Line	mm	- - -	- - -

	<b>Potenza assorbita</b> - Total Power - Puissance - Leistung - Potencia	watt	2500	2700
	<b>Tensione alimentazione</b> - Supply Voltage - Tension d'alimentation - Anschlussspannung - Alimentación	v	400V 3N~ 50Hz	400V 3N~ 50Hz

	Minimal Air Exchange	mc/h	2200	3800
--	----------------------	------	------	------

	Sound Power Level	dbA	<b>66,8</b>	<b>67,9</b>
	Sound Pressure at 5 m	dbA	<b>41,8</b>	<b>42,9</b>

	Max ambiental temperature	°C	0°C ... +32°C	0°C ... +32°C
--	---------------------------	----	---------------	---------------

	<b>Peso Netto</b> - Net weight - Poids net - Netto Gewicht	kg	<b>85</b>	<b>118</b>
--	--	----	-----------	------------