

**IT**

Struttura a monoscocca in acciaio inox AISI 304; finitura esterna satinata scotch-brite; spessore di isolamento pari a 85mm per la scocca e 65mm per la porta, con schiumatura ad alta densità (40 kg/m3) senza HFC; piedini in acciaio inox regolabili h120/150mm; cella con angoli interni arrotondati per una perfetta pulizia ed igienicità; sbrinamento ed evaporazione dell'acqua di condensa a gas caldo; griglie GN 2/1 in rislán; cremagliere porta griglie in ABS amovibili, senza l'ausilio di utensili; flusso d'aria laterale; porte auto-chiudenti da 100°; unità refrigerante a monoblocco brevettata e tropicalizzata (in classe climatica 5); serratura di serie; alimentazione a 230V/50Hz monofase standard.

**EN**

Stainless steel AISI 304 monocoque structure; scotch-brite external satin finish; 85 mm high density HFC free polyurethane foam insulation (40kg/m3) for the body and 65mm thickness for the door; stainless steel adjustable feet h120/150; cell with rounded internal edges for a perfect cleaning and hygiene; hot gas defrosting and condensation water evaporation; GN 2/1 rislán grids; removable racks for ABS grids, no tools needed; lateral air flow; self-closing doors from 100°; patented and tropicalized monobloc refrigerating unit (climatic class 5); lock as standard; standard power supply 230V/50Hz monophase.

**FR**

Structure à caisse unique en acier inox AISI 304; finition extérieure satinée Scotch-brite; épaisseur d'isolation par injection de mousse polyuréthane à haute densité (40 kg/m3) sans HFC de 85mm pour la caisse et de 65 mm pour la porte; pieds réglables h120/150mm; chambre froide avec angles internes arrondis pour un nettoyage et une hygiène parfaits; dégivrage et évaporation de l'eau de condensation par gaz chaud; grilles GN 2/1 en Rislán; crémaillères amovibles sans outils pour grilles en ABS; flux d'air latéral; porte à fermeture automatique de 100°; unité frigorifique avec monobloc breveté et tropicalisé (classe climatique 5); serrure de série; alimentation standard 230V/50Hz une seule phase.

**DE**

Monocoque-Ausführung aus Edelstahl AISI 304 mit satinierten Außenflächen (Schoch-Brite); 85 mm starke Rahmen-Isolierung und 65 mm starke Tür-Isolierung aus hochverdichtetem Polyethanschaum (40kg/m3) ohne HFC; Stellfüße aus Edelstahl H 120/150; Kühlzelle mit abgerundeten Innenecken für eine einfache Reinigung und optimale Hygiene; automatische Kondenswasserverdunstung und Abtauung durch heißen Gas; Rislán Gitter GN 2/1; ABS-Stangen für Gitter, abnehmbar ohne den Einsatz von Werkzeugen; seitliche Belüftung; selbstschließende Tür ab 100°; patentiertes und tropikalisiertes Monoblockkälteaggregat (Klimatische Klasse 5); serienmäßiges Schloss; Standard Spannung 230V/50Hz einphasig.



**ES**

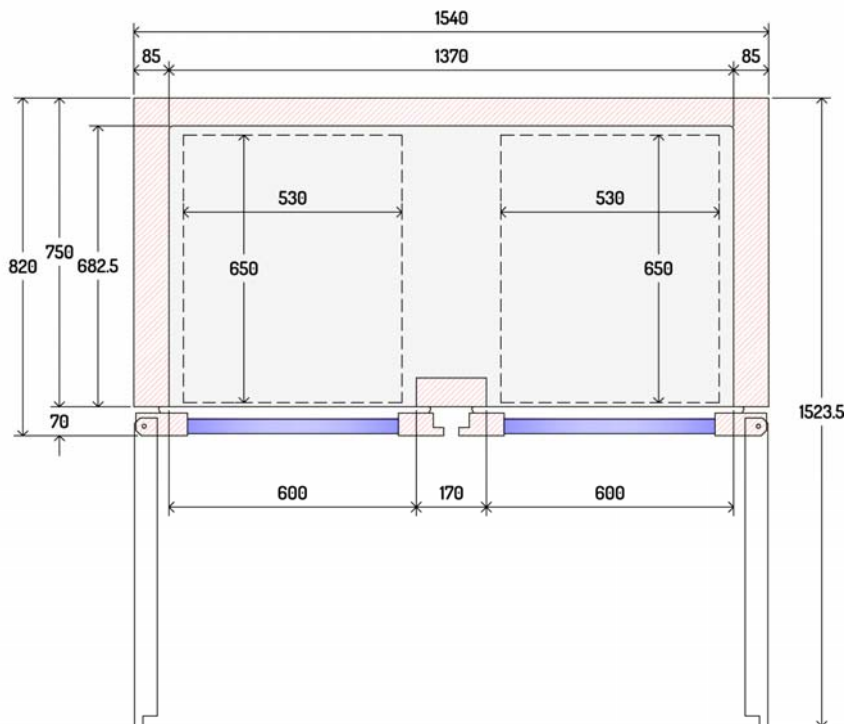
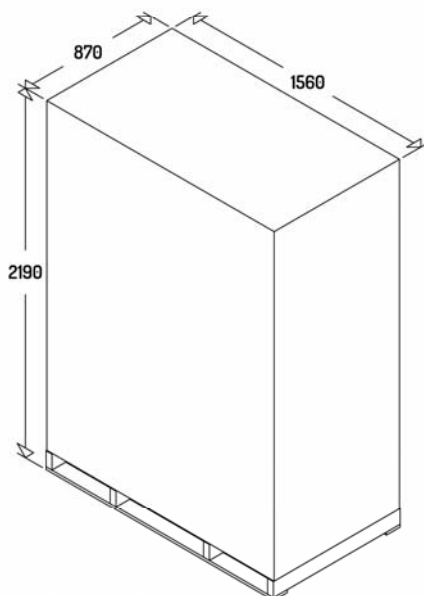
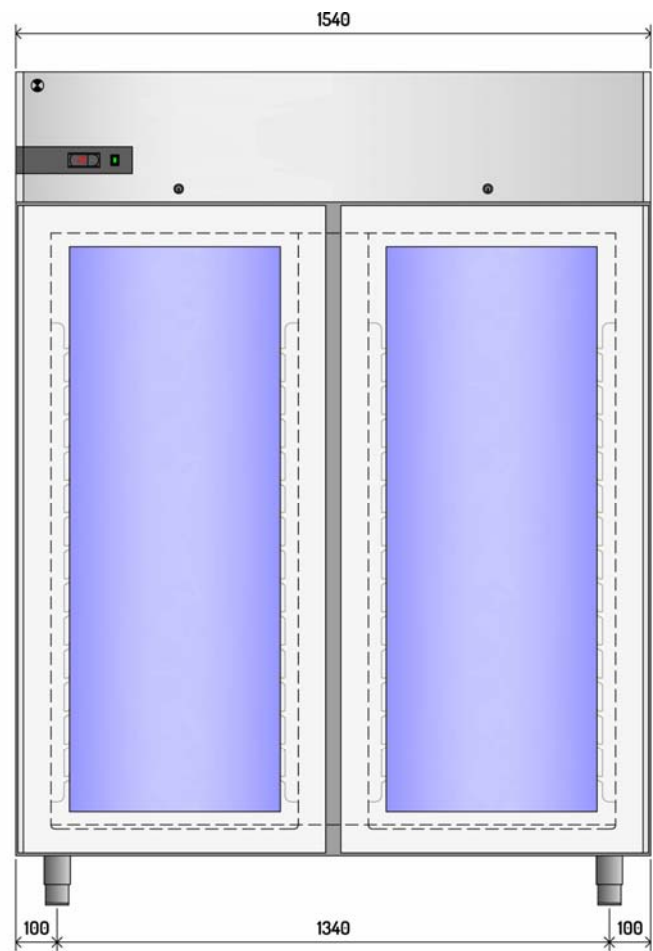
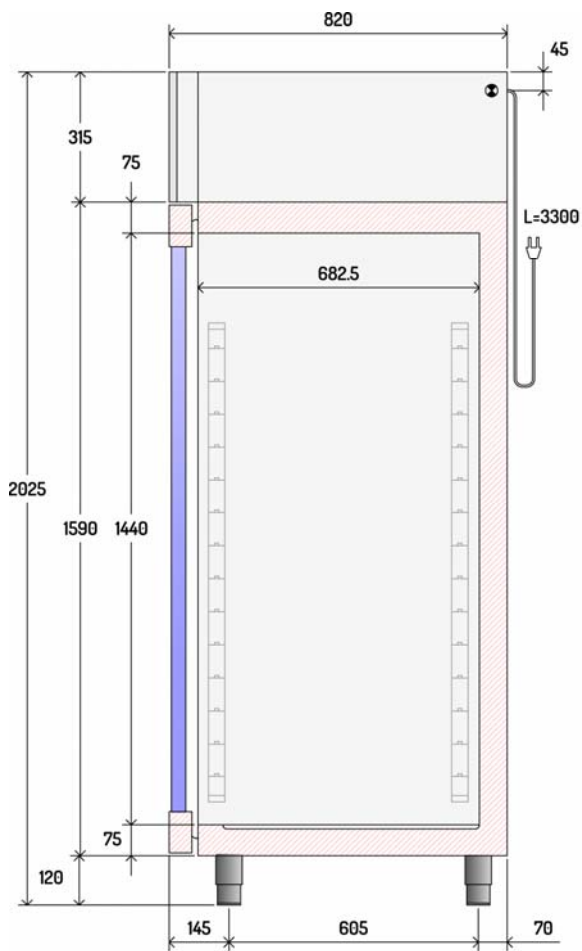

Estructura monocasco de acero inoxidable AISI 304; acabado exterior satinado scotch-brite; espesor de aislamiento 85 mm para el casco y 65 mm para la puerta con espuma de poliuretano de alta densidad (40 kg/m3) sin HFC; piés ajustable de acero inoxidable h120/150mm; cámara con equinas interiores redondeadas para un perfecta limpieza y higiene; deshielo y evaporación del agua de condensación "a gas caliente"; rejillas GN 2/1 de rislán; cremallera para rejillas de ABS extraíbles, sin el uso de herramientas; flujo de aria lateral; puertas con autocerrado con bloqueo a 100°; unidad refrigeradora monocasco patentada y tropicalizada (en clase climática 5); cerradura de serie; alimentación de 230V/50Hz monofásica estándar.

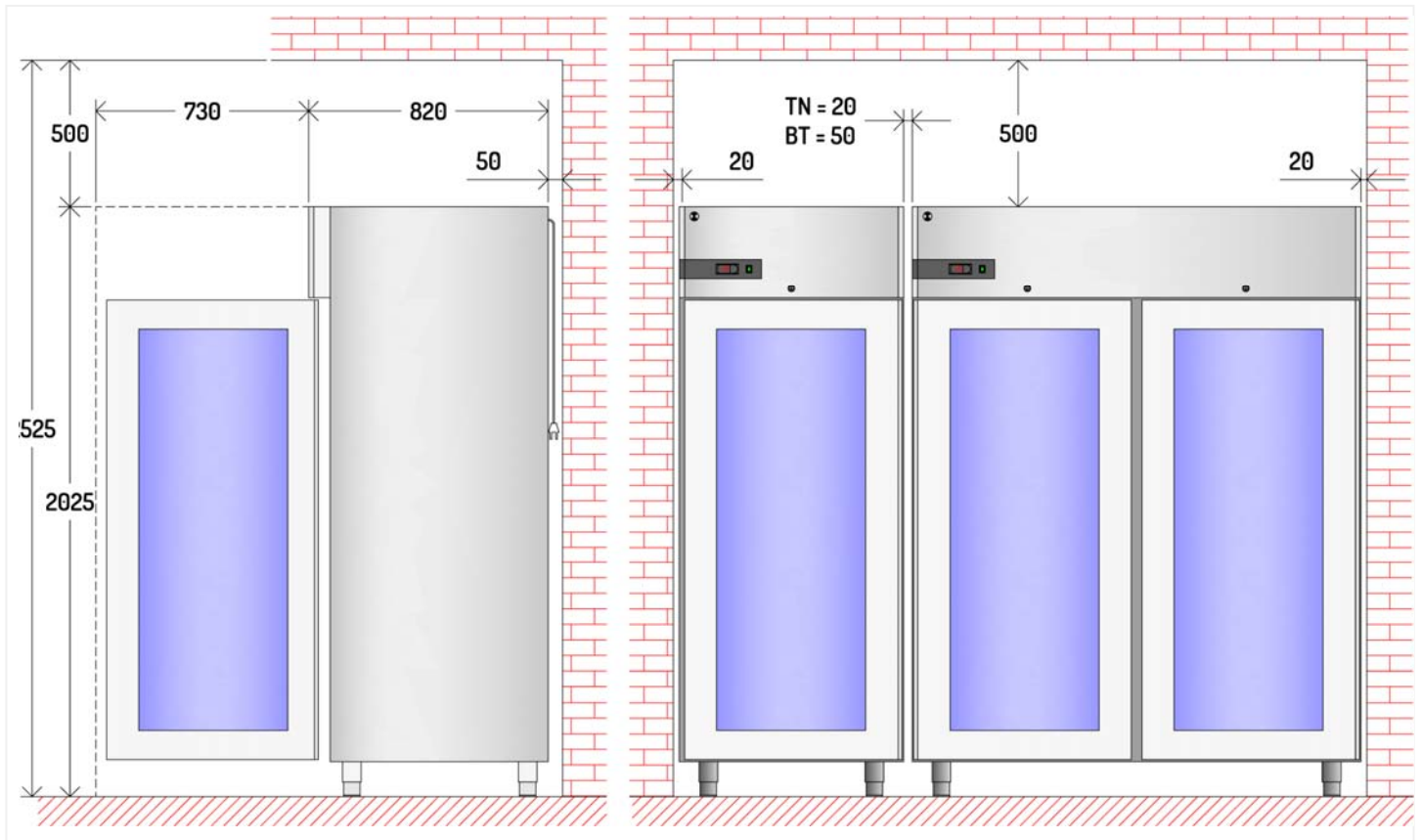



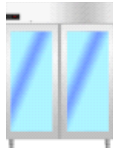

		1400 TN PV	1400 BT PV	
	<b>Ricambio Minimo Aria</b> Minimun Replacement Air	mc/h	320	720
	<b>Calore Emesso</b> Heat Output	watt	560	1160
	<b>Versione Remota</b> Remote Version			
	<b>Linea di Aspirazione</b> Suction Line	mm	ø 8	ø 10
	<b>Linea Liquido</b> Liquid Line	mm	ø 6	ø 6
	<b>Potenza Sbrinamento Elettrico</b> Electric Defrost Power	watt	450	900

Modello - Model - Model - Gerätetyp	AN14V2500	AN14V2500
	D 	E 
	NEOS GN	
<b>Descrizione</b> - Description - Description - Beschreibung	<b>1400 PV TN</b>	<b>1400 PV BT</b>
<b>Range</b>	0°C +10°C	-20°C -10°C
<b>Funzionamento</b> - Operating Mode - Mode de fonctionnemen - Betriebsmodus S = Statico - Static - Statique - Stille Kühlung V = Ventilato - Ventilated - Ventilé - Umluftkühlung	V	V
<b>Capacità lorda</b> - Gross Capacity - Capacité brute - Bruttovolumen	1340	1340
<b>Materiale Esterno</b> - External Material - Matériau Extérieur - Verstoff Außen	304	304
<b>Dimensioni esterne</b> - External Dimension - Dimensions externes - ußenabmessungen		
Lunghezza - Width - Largeur - Breite	mm 1540	mm 1540
Profondità / con porte aperte - Depth / with open doors Profondeur avec portes ouverte - Tiefe/mit geöffneter Tü	mm 820/1520	mm 820/1520
Altezza - Height - Hauteur - Höhe	mm 2025	mm 2025
<b>Materiale Interno</b> - Internal Material - Matériau Intérieur - Verstoff Innen	304	304
<b>Dimensioni interne</b> - Internal Dimension - Dimensions internes - Innenabmessungen		
Lunghezza - Width - Largeur - Breite	mm 1370	mm 1370
Profondità - Depth - Profondeur - Tiefe	mm 682,5	mm 682,5
Altezza - Height - Hauteur - Höhe	mm 1440	mm 1440
<b>Porte</b> - Doors - Portes - Türen	1, Glass	1, Glass
<b>Dotazione Standard</b> - Standard Equipment - Equipement standard - Standardausstattung	Griglia plastificata - Plastic-Coated Grid Grille Plastifiée - Kunststoff-Beschichtetes Gitter 530x650	
	3 + 3	3 + 3
<b>Luce interna</b> - Internal light - Eclairage intérieure - Innerbeleuchtung	●	●
<b>Serratura</b> - Lock - Serrure - Schloss	●	●
<b>Sbrinamento</b> - Defrost - Dégivrages - Abtauen		
Type	Hot Gas	Hot Gas
N° Defrost in 24 hrs.	3	3
Evaporazione acqua sbrinamento - Evaporation of defrost water Evaporation eau de dégivrage - Tauwasserverdunstung	Automatic by Hot Gas	Automatic by Hot Gas
<b>Compressor</b>		
Model	NEU6210U	NT2210U
Potenza - Power - Puissance - Leistung	HP 1/3	HP 1 - 1/4
T° Evaporation	°C -10	°C -30
Potenza frigorifera - Refrigerant Power - Puissance frigorifique - Kälteleistung	watt 740	watt 910
<b>Refrigerante</b> - Refrigerant type - Réfrigérant type - Kältemitteltyp	GWP R290 / 3	GWP R290 / 3
<b>Quantità di refrigerante</b> - Refrigerant quantity - Quantité de réfrigérant - Kältemittelmenge	gr 100	gr 150
<b>Potenza assorbita</b> - Total Power - Puissance - Leistung	watt 500W - 2,6A 700W - 4,9A	watt 1050W - 5,1A
<b>Tensione alimentazione</b> - Supply Voltage - Tension d'alimentation - Anschlussspannung	V 230V~ 50Hz	V 230V~ 50Hz
<b>Noise Level</b>	dbA 49	dbA 61
<b>Peso Netto</b> - Net weight - Poids net - Netto Gewicht	kg 280	kg 290
<b>Versione Predisposta</b> - Remote version - Version sans groupe - Modelle ohne Aggregat Sbrinamento elettrico - Electrical defrosting - Dégivrage électrique - Elektrische Abtaung	---	---
<b>Efficienza Energetica</b> - Energy Efficiency - Classe Énergie - Energieeffizienzklasse	D	E
<b>Energia</b> - Energy - Énergie - Energie	kWh / annum 1675	kWh / annum 5537
<b>Volume Netto</b> - Net Volume - Volume Net - Nettoinhalt	l 1096	l 1096
<b>Classe Climatica</b> - Climate Class - Classe Climatique - Klima Klasse	4 30°C-55%	4 30°C-55%

●= Dotazione di serie - Standard equipment - Dotation standard - Serien Ausstattung □=Optional